

# NCP11184A65P25WGEVB



ON Semiconductor®

[www.onsemi.com](http://www.onsemi.com)

## 25 W Auxiliary Power Supply for White Goods and Industrial Equipment with NCP11184A65

### EVAL BOAR USER'S MANUAL

#### GENERAL SPECIFICATIONS

Devices	Applications	Topology	Output Power	Input Voltage	Output Spec.
NCP11184A65	White Goods and Industrial Power Supplies	Isolated Flyback	25 W	84–265 Vac	12 V / 1.9 A & 15 V / 0.15 A
Efficiency	Standby Power	Package Temperature	Operating Temperature	Cooling Method	Board Size
> 87% @ Full-load	< 40 mW @ 230 Vac	74°C @ T <sub>A</sub> = 50°C	0–50°C	Natural Convection In Open Frame	121 x 50 x 30 mm 4.06 W/inch <sup>3</sup>

#### Description

This design note introduces not only performance of a reference design with 25 W isolated flyback converter using NCP11184 for auxiliary power supplies but also provides key experimental results and information.

NCP1118x is a highly enhanced switcher integrating a peak current mode PWM controller employing mWSaver and frequency reduction technology and a highly robust 800 V Super-junction II MOSFET. Additionally, it features a high-voltage startup circuit, frequency reduction, slope compensation, constant output power limit, and highly reliable and various protections. As a result, it allows designing cost-effective off-line power supplies using NCP1118x with less BOM counts and smaller PCB size and high efficiency as well. Additionally, it could get low standby power consumption less than typically 40 mW despite of multiple outputs.

On top of that, NCP1118x features variety of protections for highly reliable power supply design such as a feedback pin open-loop protection (OLP), current-sense resistor short protection (CSSP), brown-out, line over-voltage protection (Line-OVP) using an line voltage sensing pin operated with auto-recovery operation and constant over-power protection. This design note demonstrates those protections under various conditions.

#### Key Features

- Peak Current Mode Controller Integrated 800 V SJ-II MOSFET, High Voltage Start-up, Soft-Start, and Slope Compensation
- mWSaver Technology Provides Industry's Best-in-Class Standby Power
- Switching Frequency Option: 65/100/130 kHz
- Proprietary Asynchronous Frequency Hopping Technique for Low EMI
- Programmable Constant Output Power Limit for Entire Input Voltage Range
- Precise Brown-out Protection and Line Over-voltage Protection (LOVP) with Hysteresis
- Current Sense Short Protection (CSSP) and Abnormal Over-Current Protection (AOCP)
- Thermal Shutdown (TSD) with Hysteresis
- All Protections Operated by Auto-recovery: VCC Under-voltage Lockout (UVLO), Feedback Open-Loop Protection (OLP), VCC Over-Voltage Protection (OVP)

# NCP11184A65P25WGEVB

## REFERENCE BOARD SCHEMATIC & DESCRIPTION

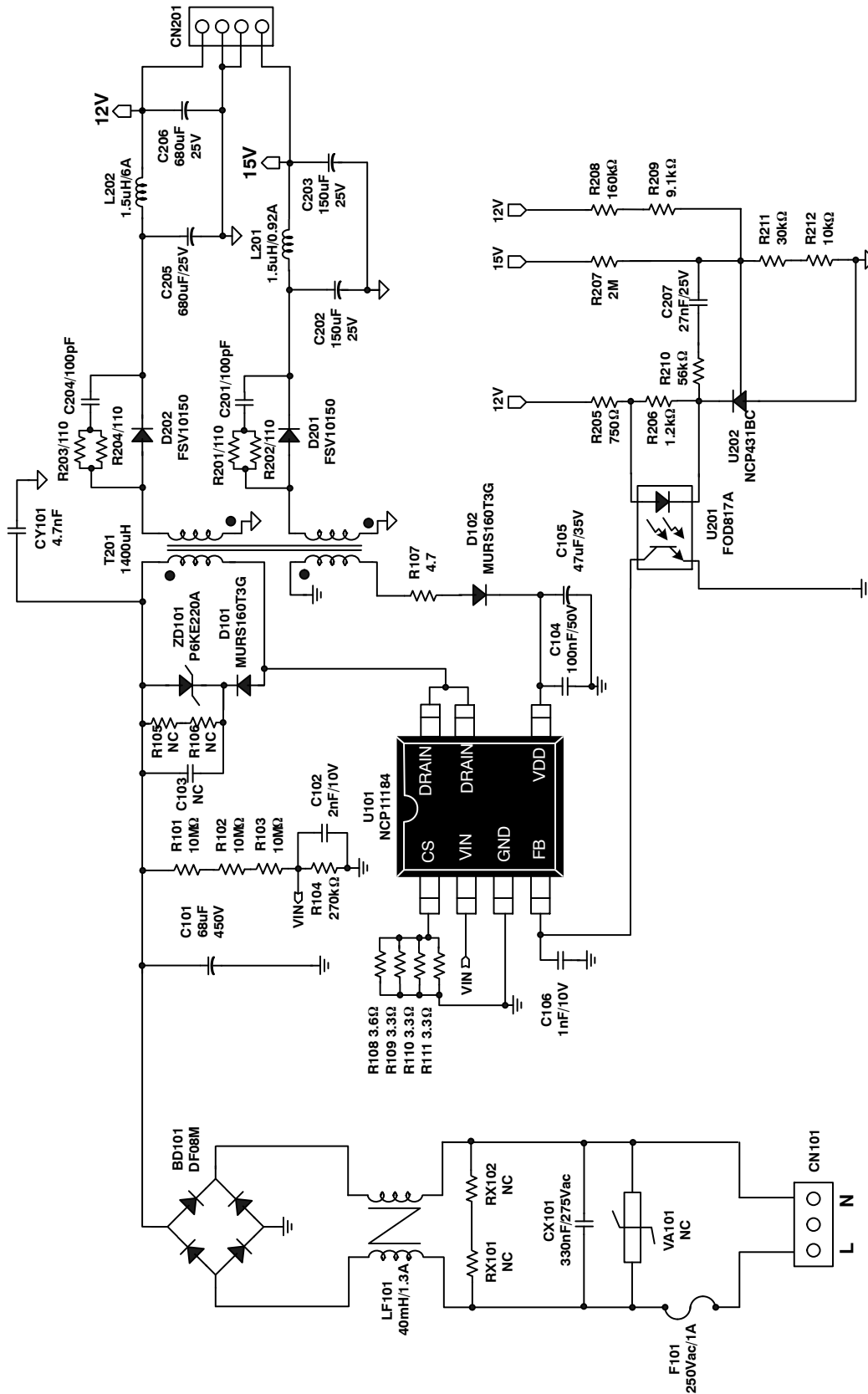

Figure 1. Reference Board Schematic

## NCP11184A65P25WGEVB

This reference board comprises four parts overall, EMI filter, primary side control, secondary output and feedback circuit part. For more detail, these parts could be described as following.

1. *EMI filter* is formed by components of a common-mode filter LF101, X-capacitors CX101 and Y-capacitor CY101.
2. *Primary side control part* in flyback converter in flyback converter consists of NCP11184 switcher U101, a power transformer T201, a bulk capacitor C101, a full-wave rectifier BD101, a snubber circuit ZD101 and D101 and line input voltage sensing R101~R104 and C102. Additionally,  $V_{CC}$  bias is powered for from the auxiliary winding of T201 and related components of D102, R107, C104 and C105 during normal operations. The resistor array of R108~R111 is for drain current sensing resistor and connected to CS pin. The sensed drain current is used in peak current mode control and some protections e.g. pulse-by-pulse current limit, AOC (Abnormal Over-current Limit) and CSSP (Current-sensing Short Protection) and etc. In this reference board, TVS (Transient Voltage Suppressor) is utilized for a snubber to suppress voltage spike produced by leakage inductance at MOSFET turn-off. Optionally, RCD snubber can be used since component places of R105, R106 and C103 is already assigned, if needed. Meanwhile, C102 is

used to decouple high frequency switching noise from line sensing signals. It is typically 1nF~3.3nF in this sensing method, but should be adjusted considering real noises in an actual experiment.

3. *Secondary side output stage* has two output terminals (12 V / 1.9 A and 15 V / 0.15 A) and associated components such as output diodes D201, D202, output capacitors C202, C203 and C205, C206 with filter inductors L201, L202, and RC snubber R201~R204 and C201, C204 for the output diodes. The output capacitors and filter inductors are formed as pi-type filter to reduce output voltage ripple while rejecting high frequency switching noise.
4. *Feedback circuit at the secondary side* employs dual feedback circuit with two poles & one zero to increase feedback loop response and reduce voltage variation on the unregulated output voltage caused by cross-regulation depending on load variation. Main regulated output is 12 V-output through feedback circuits of resistors R208, R209, R211, R212 and R205, a voltage reference U202 and an opto-coupler U201. The 15 V-output voltage can be also sensed and affect feedback loop with low weight through R207. R210 and C207 provides one pole and zero and should be adjusted considering feedback response in an actual experiment.



# NCP1184A65P25WGEVB

## PHOTOGRAPH OF REFERENCE BOARD

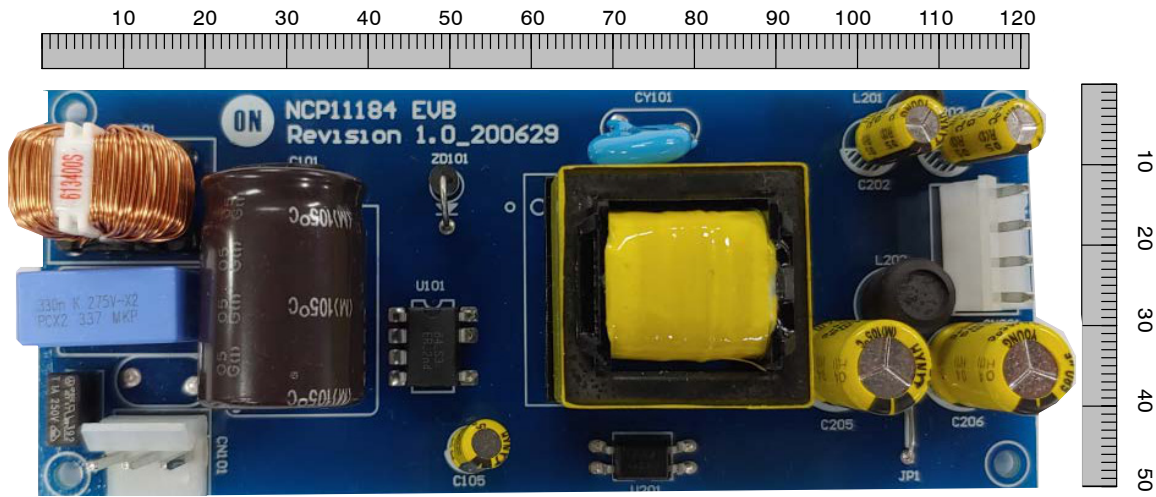

Figure 4. Photograph of Reference Board (Top)

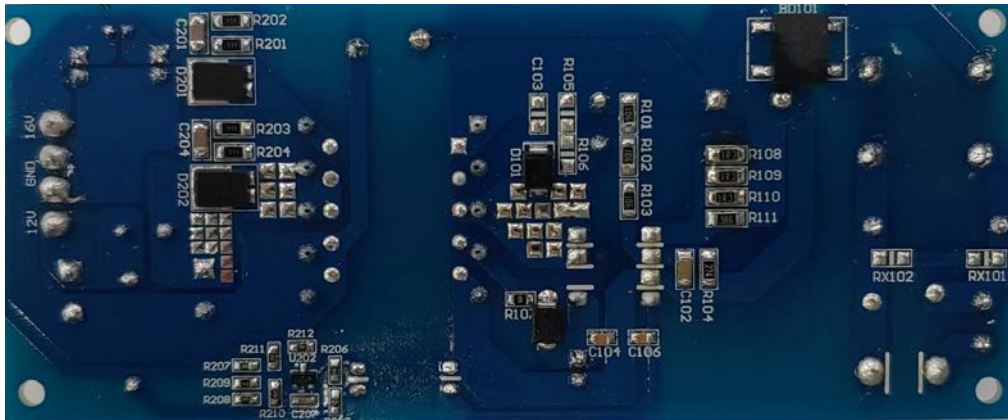

Figure 5. Photograph of Reference Board (Bottom)

# NCP11184A65P25WGEVB

## TRANSFORMER SPECIFICATION

### TRANSFORMER OVERALL SPECIFICATION

	Value	Note
Core	EE25	TDK
Bobbin	EE25 bobbin	SUMMITOMO BAKELITE CO LTD
Primary-side Inductance	1400 $\mu$ H (typ)	Measure pin 1 to 3 @ 100 kHz & 1 V
Leakage Inductance	10 $\mu$ H	Short all pin except primary-side winding

### TRANSFORMER OVERALL SPECIFICATION

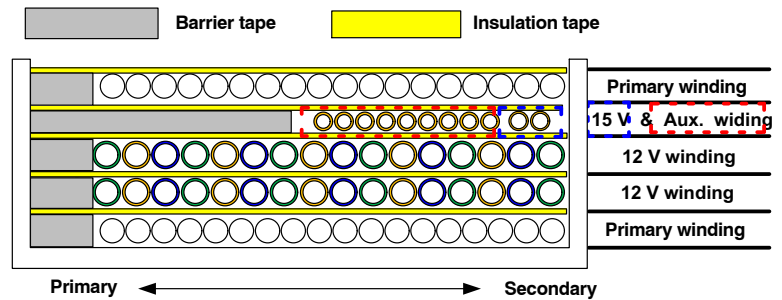
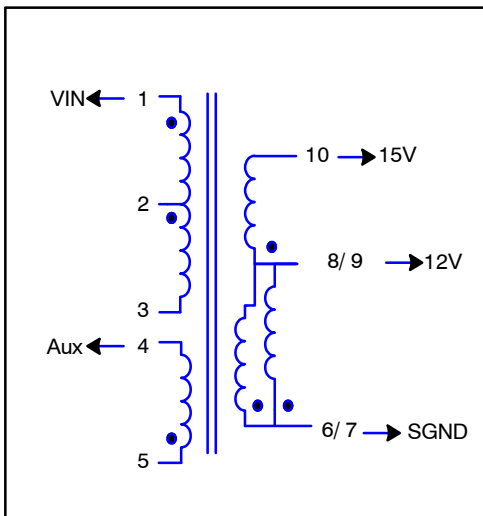

### TRANSFORMER WINDING METHOD

Order	Winding Name	Wire - Diameter	Number of Strands	Start - Finish	Turns	Insulation Tape Turns
1	$N_p$	UEW- $\varnothing$ 0.3	1	1-2	32	2 <sup>TS</sup>
2	$N_{12V}$	TIW- $\varnothing$ 0.4	2	6-8	8	2 <sup>TS</sup>
3	$N_{12V}$	TIW- $\varnothing$ 0.4	2	7-9	8	2 <sup>TS</sup>
4	$N_{16V}$	TIW- $\varnothing$ 0.22	1	9-10	2	2 <sup>TS</sup>
5	$N_{AUX}$	TIW- $\varnothing$ 0.22	1	5-4	8	2 <sup>TS</sup>
6	$N_p$	UEW- $\varnothing$ 0.3	1	2-3	31	2 <sup>TS</sup>

# NCP11184A65P25WGEVB

## STANDBY POWER

1. STBY @ no load

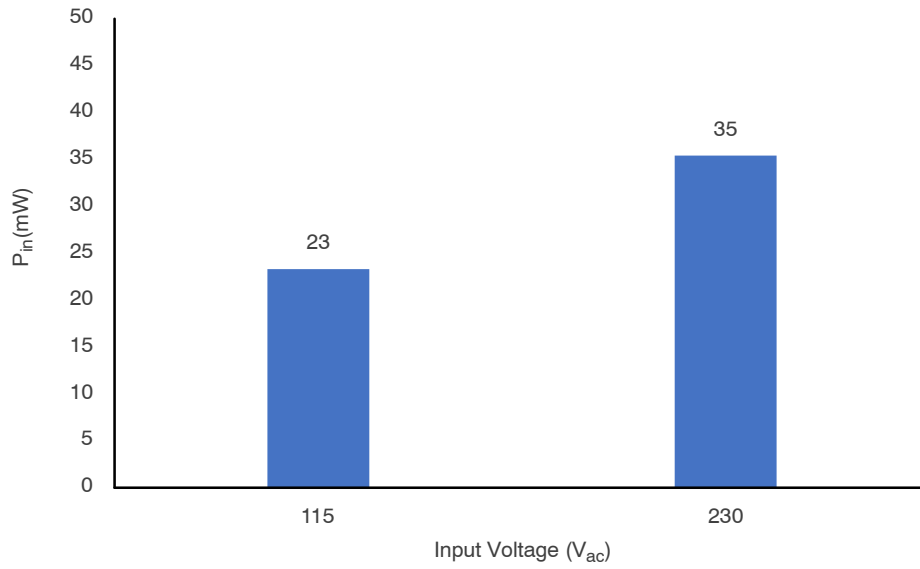

Figure 6. No Load Power Consumption

2. STBY @ load variation from 0.5 W to 10 W

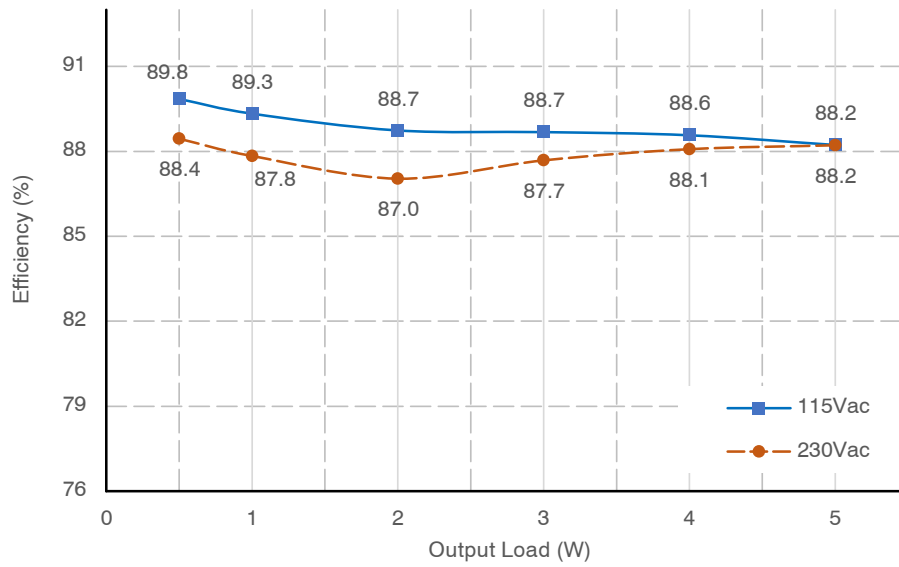

Figure 7. Standby Power at Light Load Condition

# NCP11184A65P25WGEVB

## EFFICIENCY

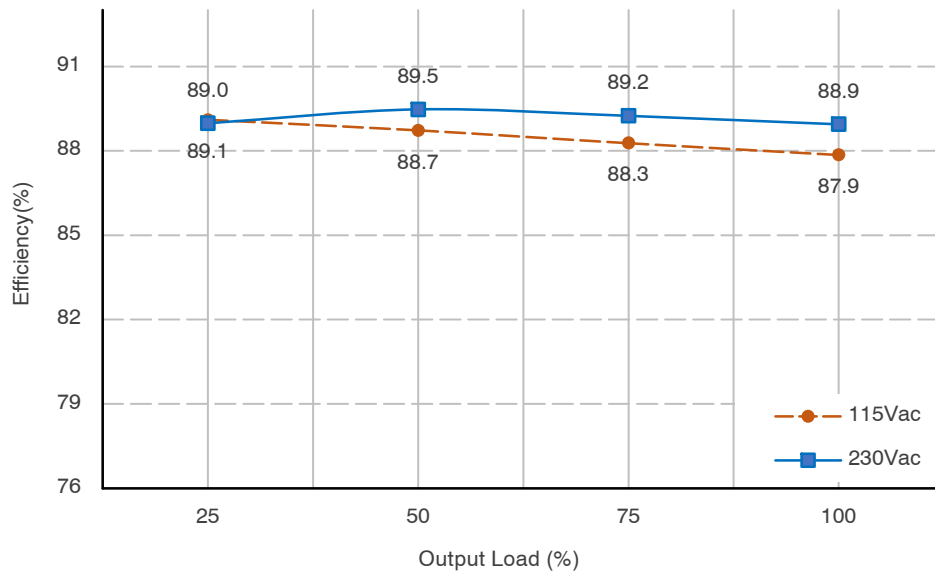

Figure 8. Efficiency at 4 Points Load

## CONSTANCE OVER POWER LIMIT (COPL)

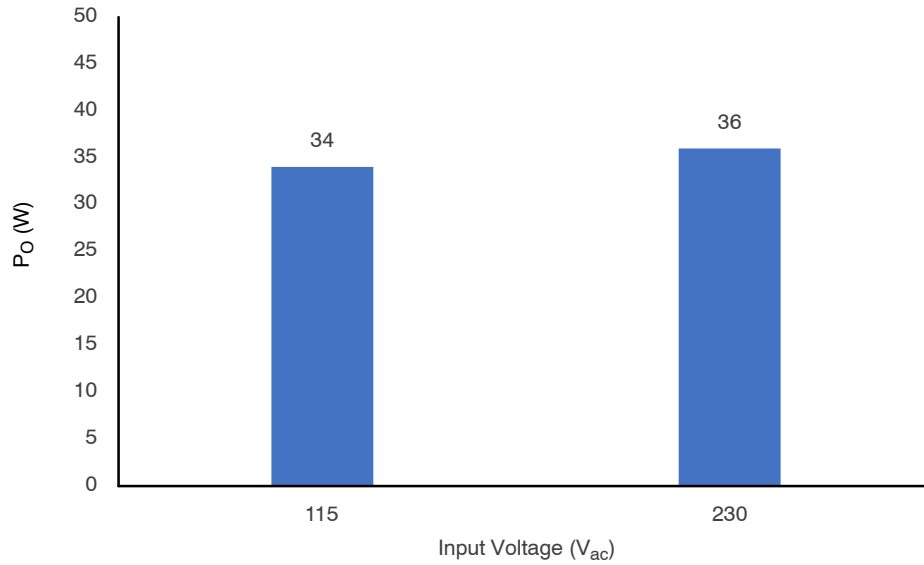

Figure 9. Over Power Depending on Input Voltage



# NCP11184A65P25WGEVB

## TEMPERATURE OF COMPONENTS

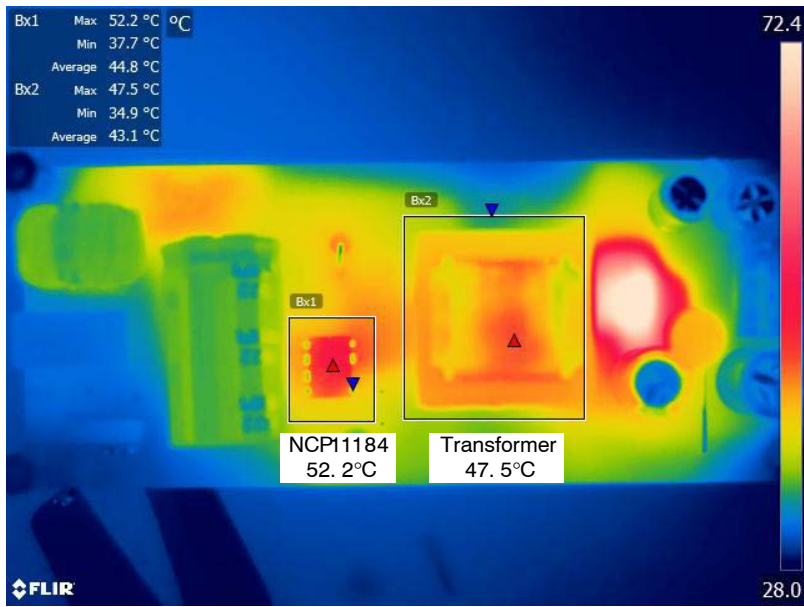

Figure 10. Temperature of the Reference Board @ 115 V<sub>ac</sub>/60 Hz

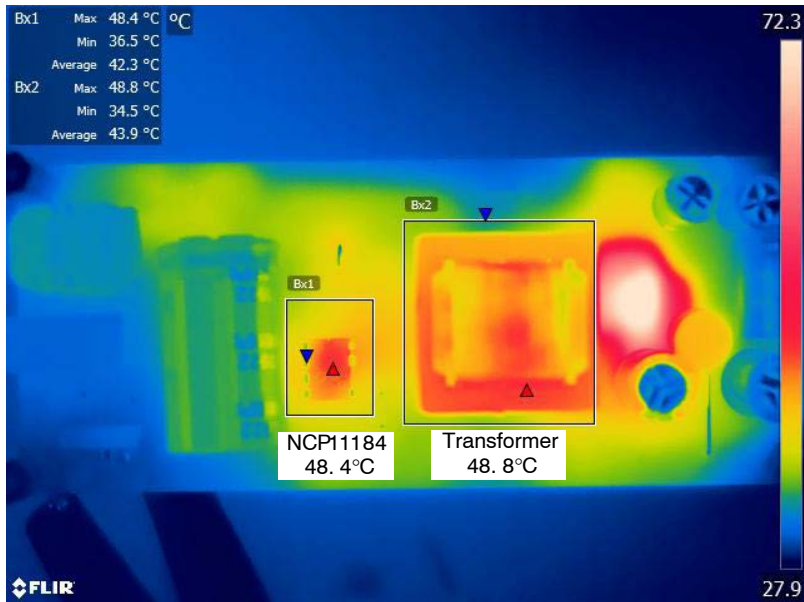

Figure 11. Temperature of the Reference Board @ 230 V<sub>ac</sub>/60 Hz

# NCP11184A65P25WGEVB

## EMI PERFORMANCE

### Test Conditions:

- Test Conditions
  - ◆ Output: 20.7 W (12 V / 7.5  $\Omega$ , 15 V / 150  $\Omega$ )
  - ◆ Test Standard: EN 55022 Class B Conducted Emission

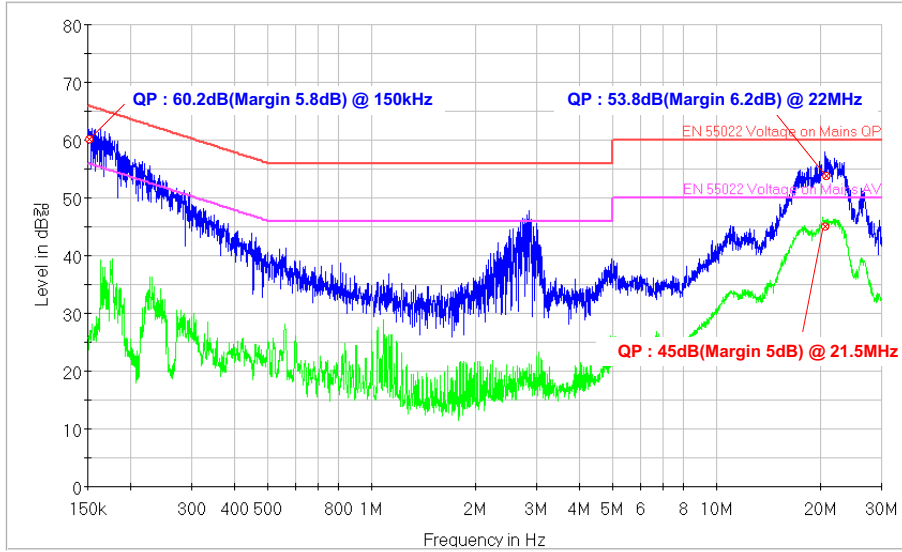

Figure 12. EMI Performance @ 110 V<sub>ac</sub>

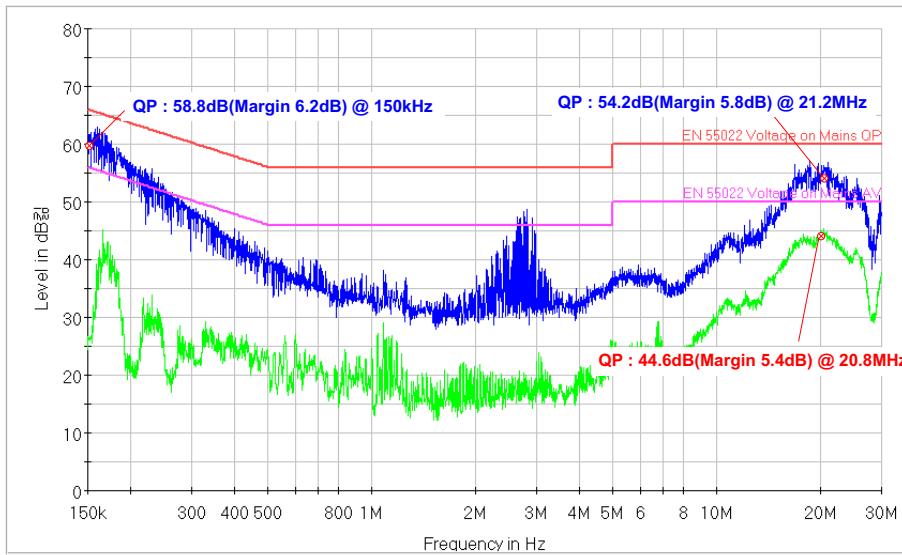

Figure 13. EMI Performance @ 220 V<sub>ac</sub>

# NCP11184A65P25WGEVB

## KEY OPERATIONS OF EVB

### NOMENCLATURE

Name	Description
$V_{AC}$	Line input voltage
$V_D$	Drain voltage
$I_D$	Drain current
$V_{CC}$	VCC pin voltage
$V_{FB}$	Feedback voltage
$V_{LINE}$	Line pin voltage
$V_{O-12V}$	12 V output voltage
$V_{O-15V}$	15 V output voltage
$t_{startup}$	Time from when the AC switch is turned on until the output voltage reaches 90%.
$f_s$	Operation frequency
$V_{FB-BUR}$	Burst-mode Start Threshold Voltage
$V_{FB-BURH}$	Burst-mode End Threshold Voltage
$t_{D-VNOFF}$	Brown-out Debounce Time
$N_{VINOV}$	VIN OVP Debounce Counting Number
$t_{D-OLP}$	FB OLP Debounce Time
$N_{CSSP}$	CSSP Debounce Counting Number

### Operation Contents

1. Startup Operation
2. Normal Operation
3. Output Ripple Voltage
4. Burst Mode In/Out
5. Load Transient
  - a. Load Change: 20%→80%
  - b. Load Change: 80%→20%
6. Protection
  - a. Brown Out
  - b. Line Over Voltage Protection (LOVP)
  - c.  $V_{CC}$  Over Voltage Protection (OVP)
  - d. Over Load Protection (OLP)
  - e. Current Sense Short Protection (CSSP)
    - Startup after sensing resistor short
    - Short sensing resistor while normal operation
  - f. Thermal Shutdown Protection (TSD)

# NCP11184A65P25WGEVB

## 1. Start-up Operation

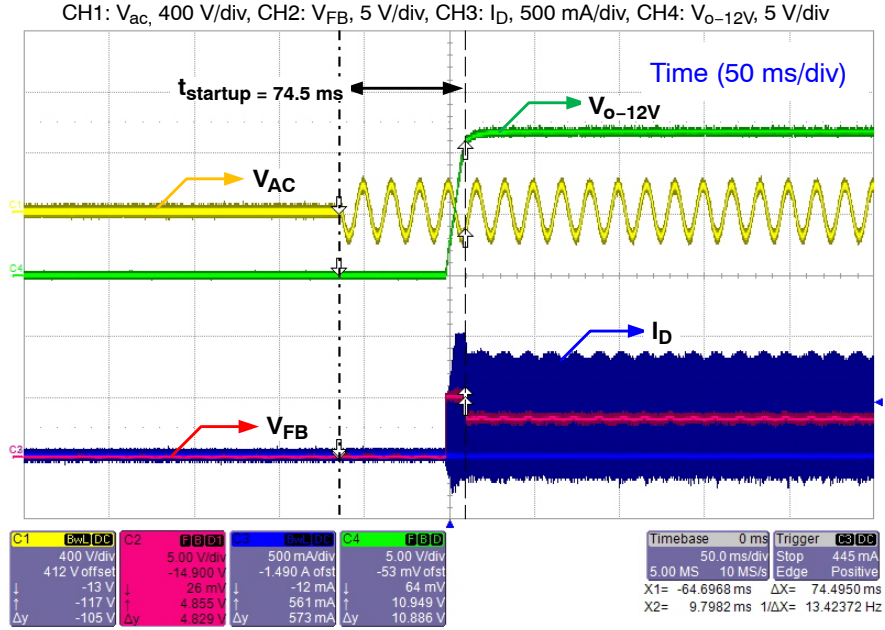

Figure 14. Star-up Operation @ 115  $V_{ac}$ /60 Hz, Full Load

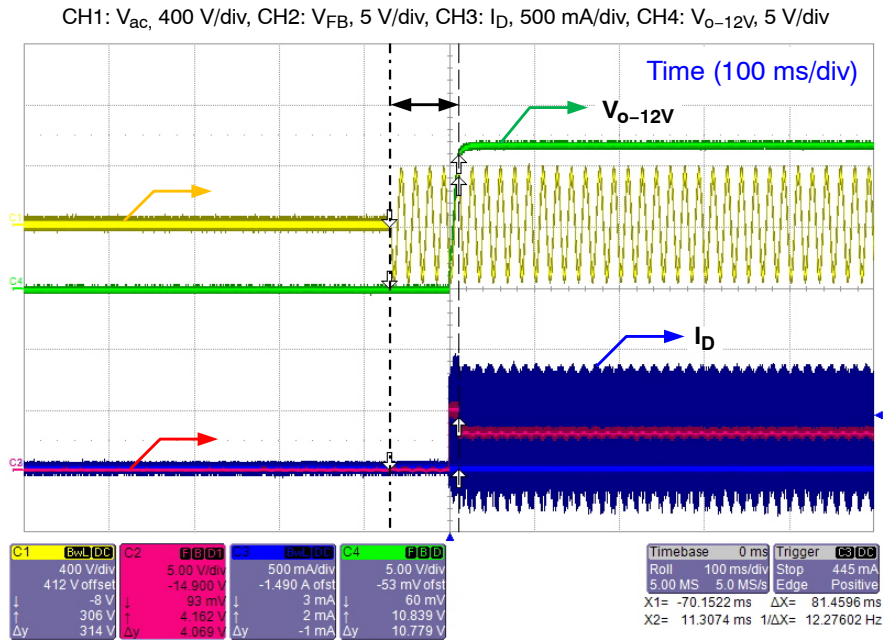

Figure 15. Star-up Operation @ 230  $V_{ac}$ /60 Hz, Full Load

# NCP11184A65P25WGEVB

## 2. Normal Operation

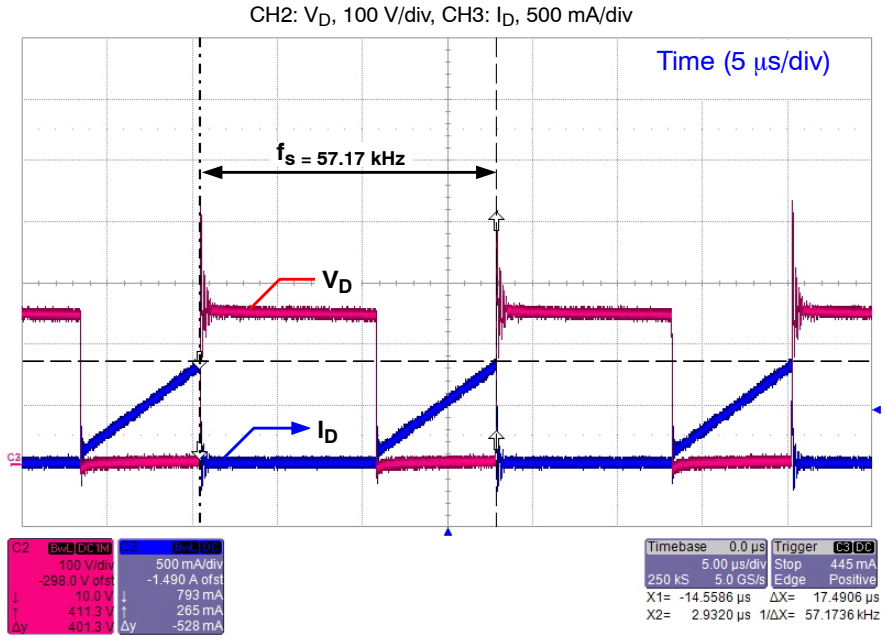

Figure 16. Normal Operation @ 115  $V_{ac}$ /60 Hz, Full Load

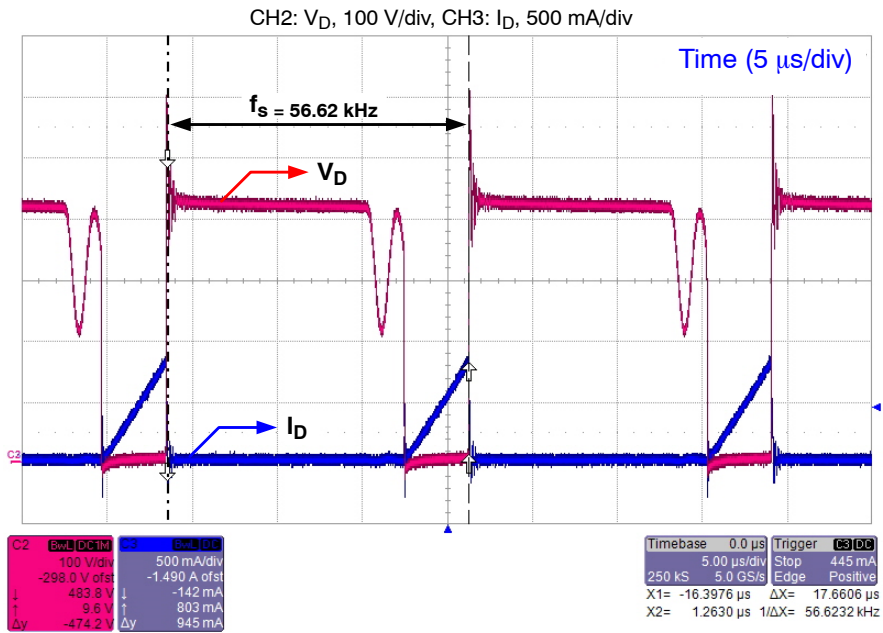

Figure 17. Normal Operation @ 230  $V_{ac}$ /60 Hz, Full Load

# NCP11184A65P25WGEVB

## 3. Output Ripple Voltage

### ◆ Test method

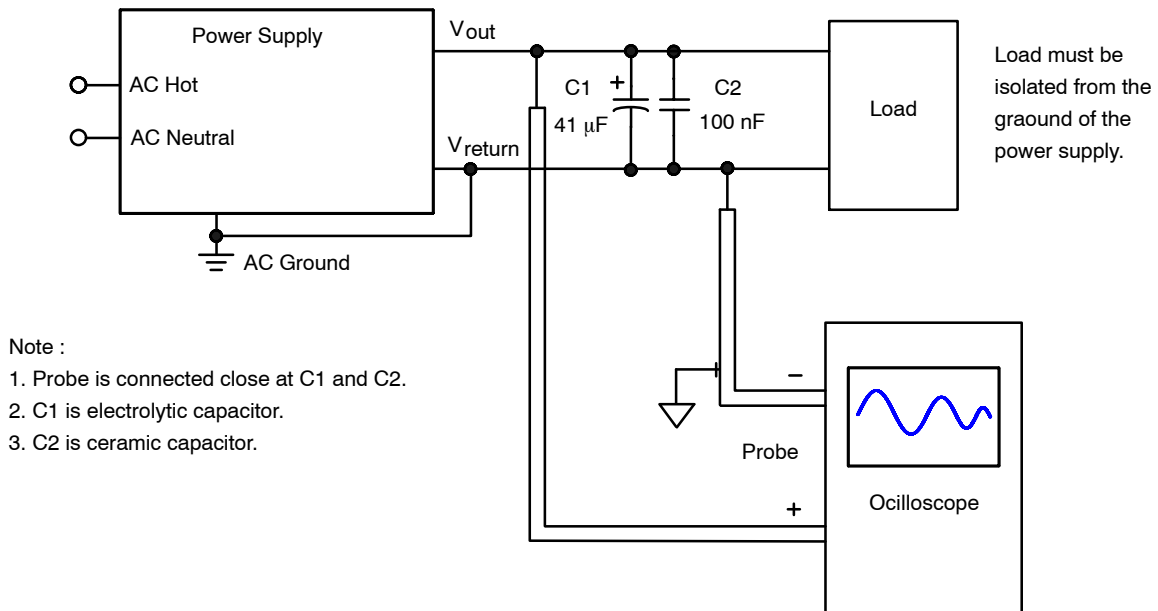

Figure 18. Test Method for Output Ripple and Noise

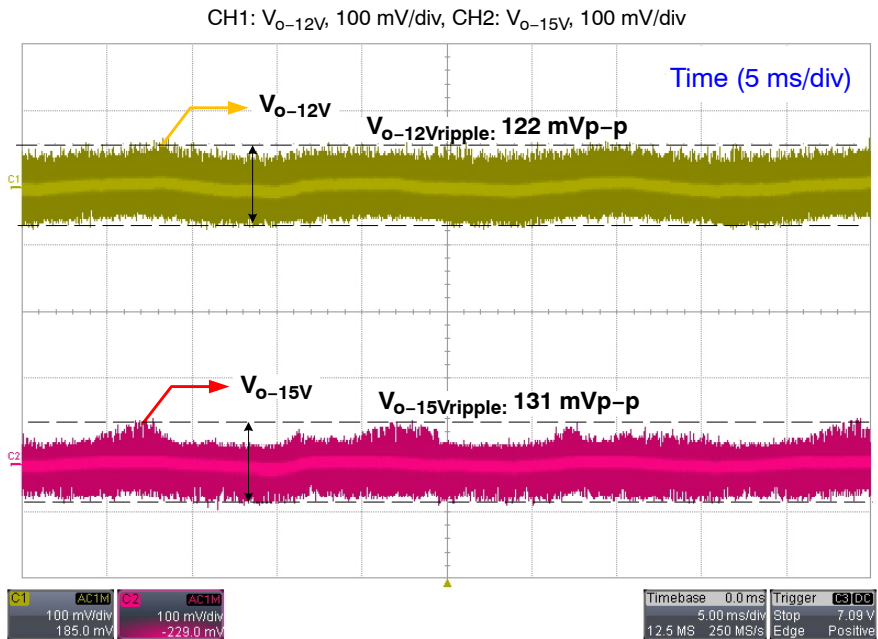

Figure 19. Output Ripple Voltage @ 115  $V_{ac}$ /60 Hz, Full Load

# NCP11184A65P25WGEVB

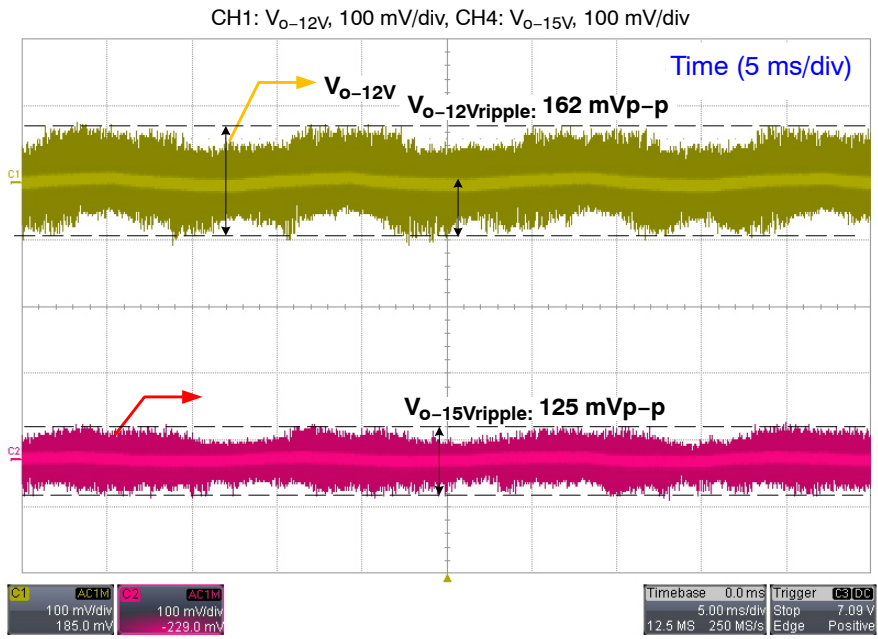

Figure 20. Output Ripple Voltage @ 230  $V_{ac}$ /60 Hz, Full Load

# NCP11184A65P25WGEVB

## 4. Burst Mode In/Out

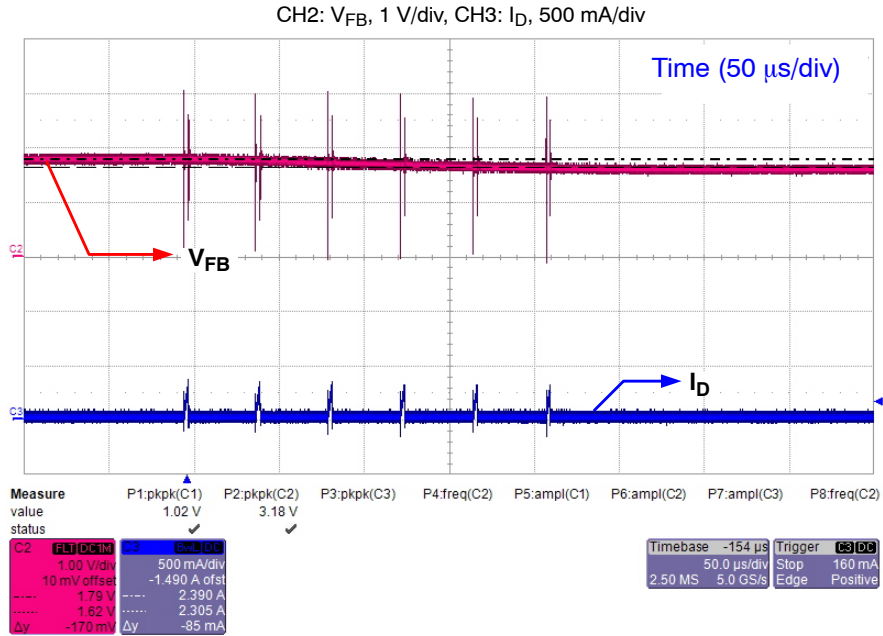

Figure 21. Burst Mode @ 115 Vac/60 Hz, No Load

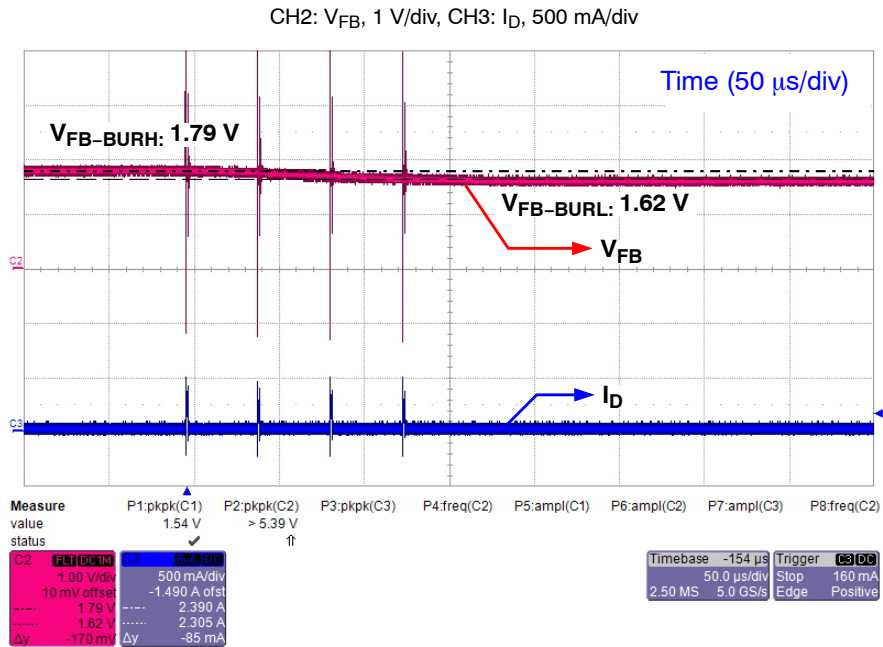

Figure 22. Burst Mode @ 230 Vac/60 Hz, No Load



# NCP11184A65P25WGEVB

## 5. Load Transient

a. Load Change: 20%→80%

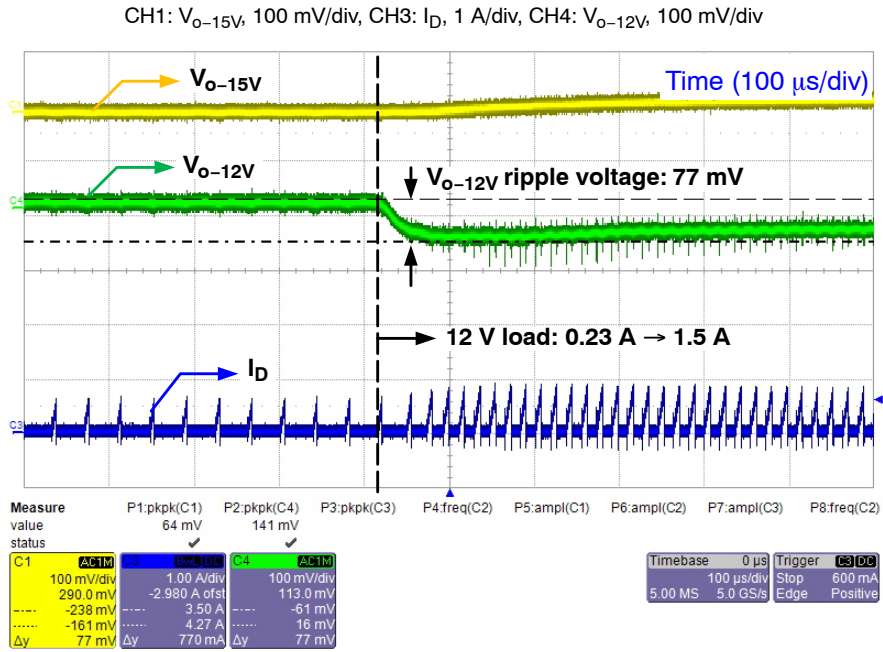

Figure 23. Load Transient @ 115 Vac/60 Hz

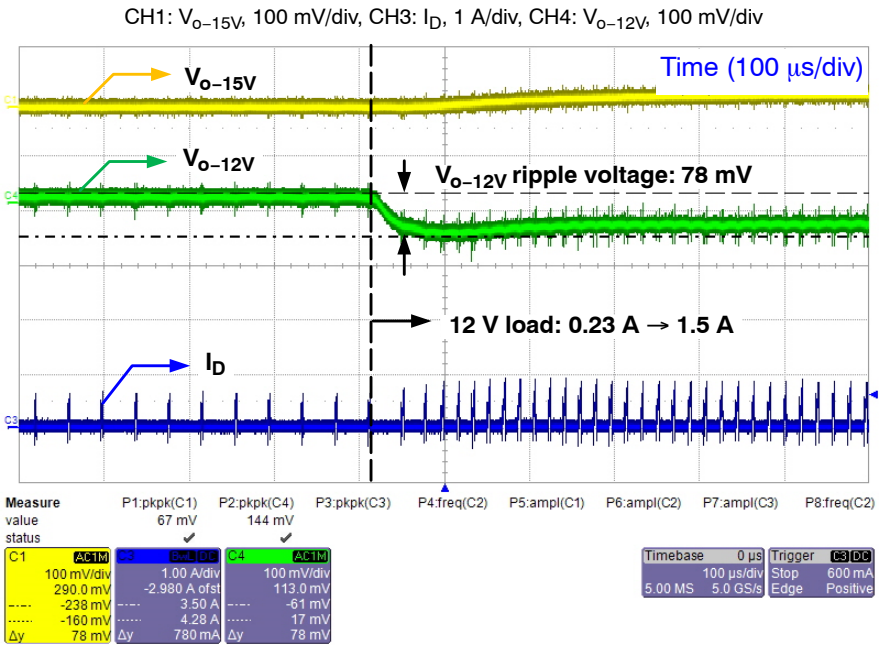

Figure 24. Load Transient @ 230 Vac/60 Hz

# NCP11184A65P25WGEVB

b. Load Change: 80%→20%

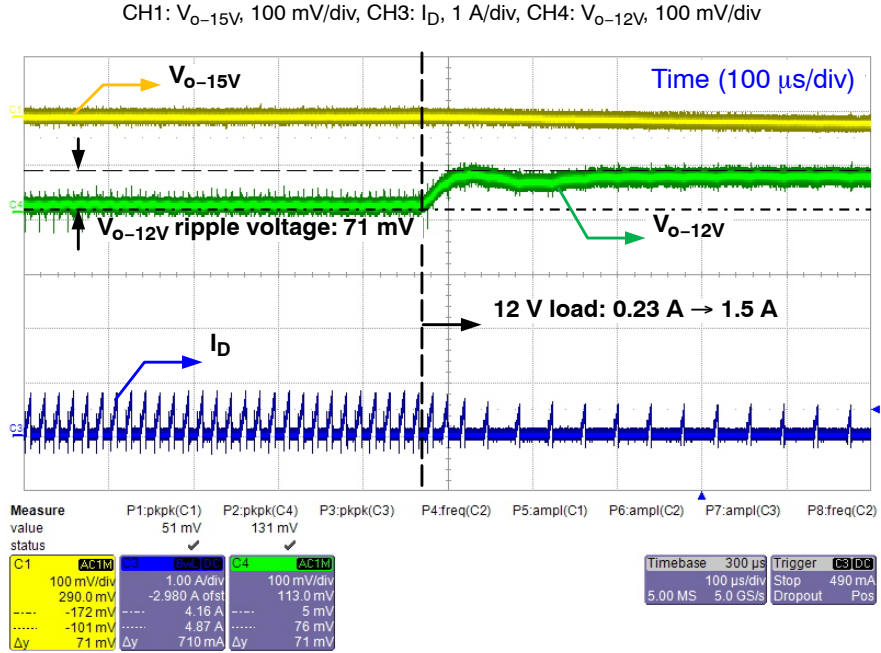

Figure 25. Load Transient @ 115 Vac/60 Hz

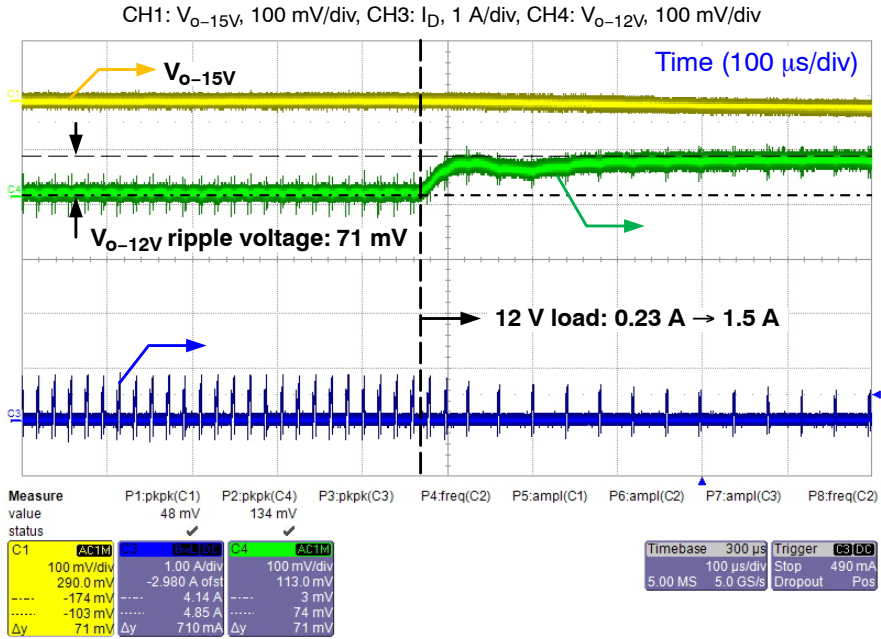

Figure 26. Load Transient @ 230 Vac/60 Hz

# NCP11184A65P25WGEVB

## 6. Protection

### a. Brown Out

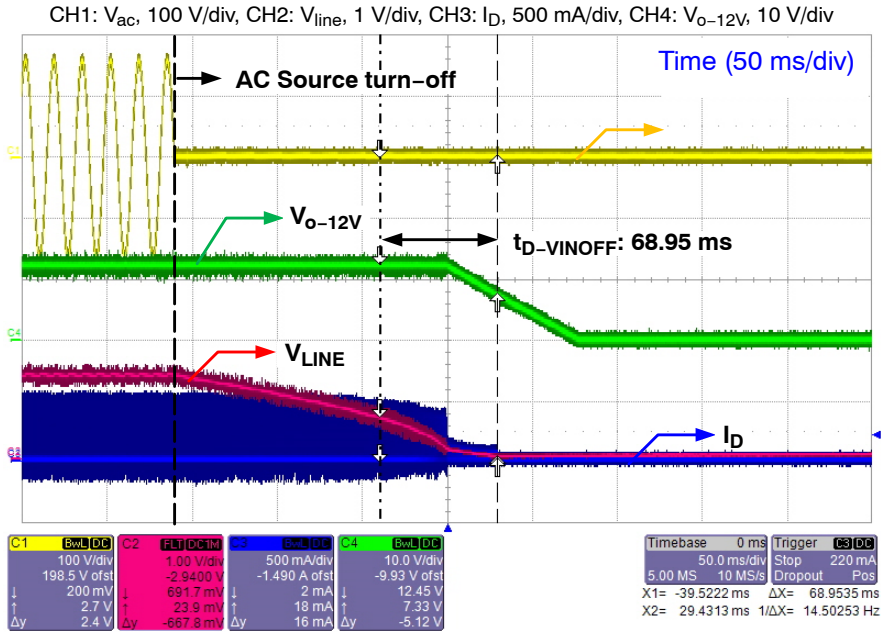

Figure 27. Brown Out @ Full Load

### b. Line Over Voltage Protection (LOVP)

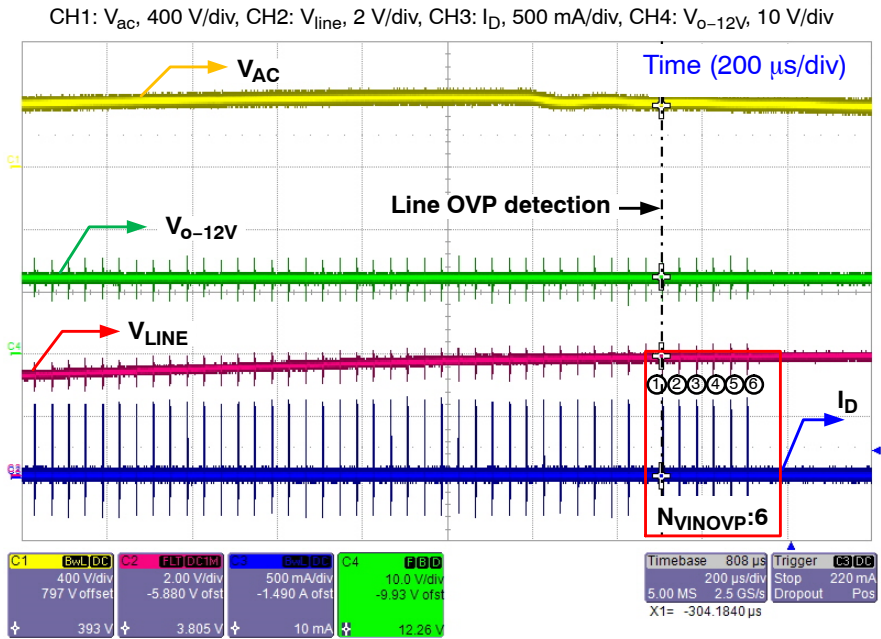

Figure 28. LOVP @ Full Load

# NCP11184A65P25WGEVB

## c. VCC Over Voltage Protection (OVP)

CH1:  $V_{CC}$ , 10 V/div, CH2:  $V_{FB}$ , 2 V/div, CH3:  $I_D$ , 500 mA/div, CH4:  $V_{O-12V}$ , 10 V/div

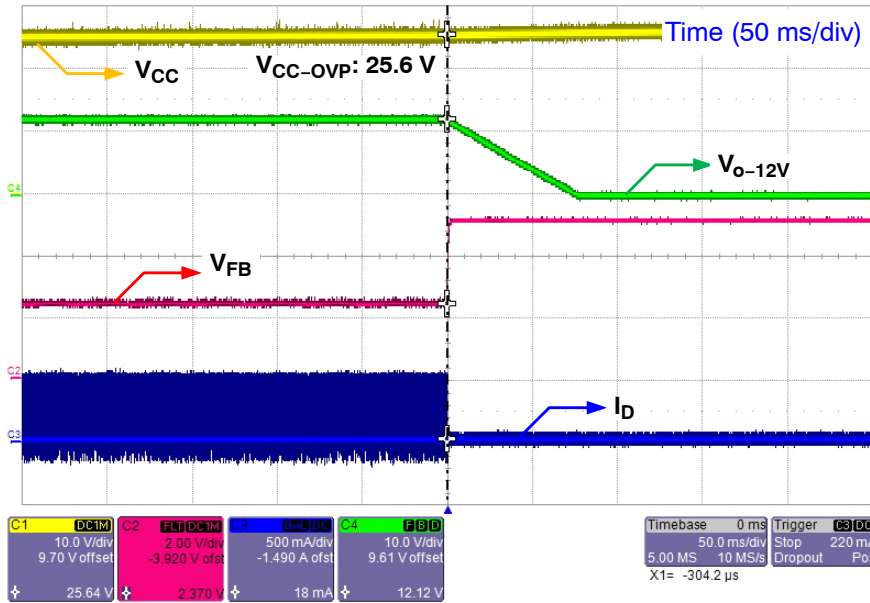

Figure 29.  $V_{CC}$  OVP @ 115  $V_{ac}$ /60 Hz, Full Load

CH1:  $V_{CC}$ , 10 V/div, CH2:  $V_{FB}$ , 2 V/div, CH3:  $I_D$ , 500 mA/div, CH4:  $V_{O-12V}$ , 10 V/div

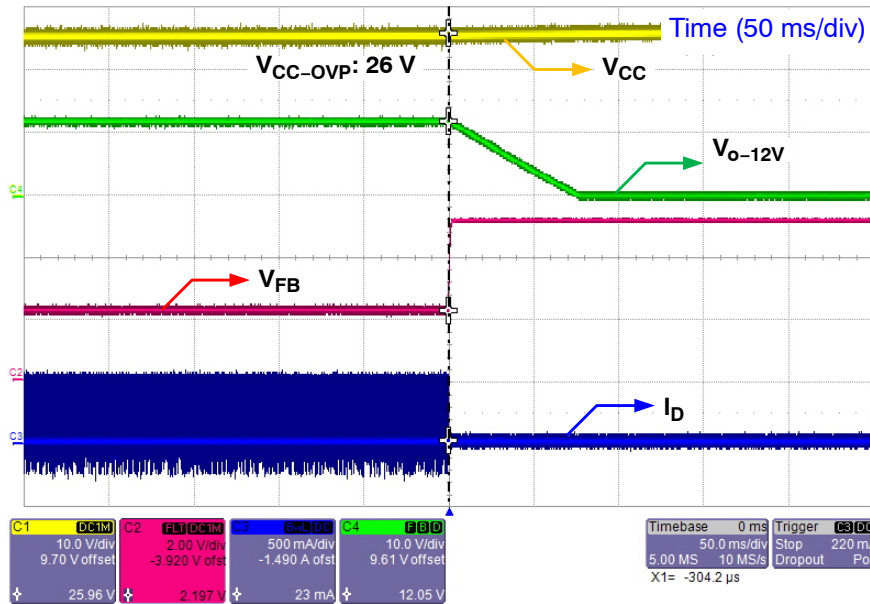

Figure 30.  $V_{CC}$  OVP @ 230  $V_{ac}$ /60 Hz, Full Load

# NCP11184A65P25WGEVB

## d. Over Load Protection (OLP)

- ◆ Test method: Output short during operation

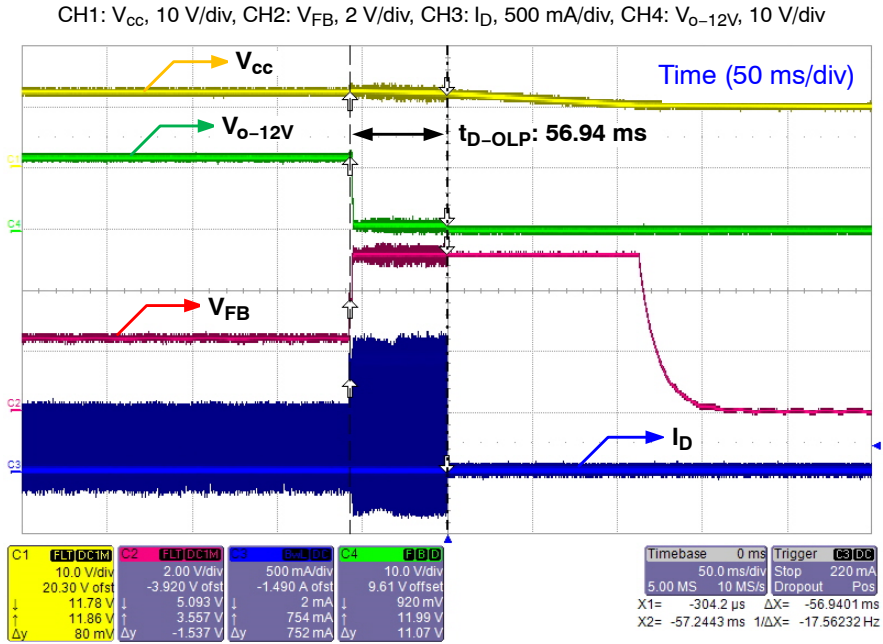

Figure 31. OLP @ 115  $V_{ac}$ /60 Hz

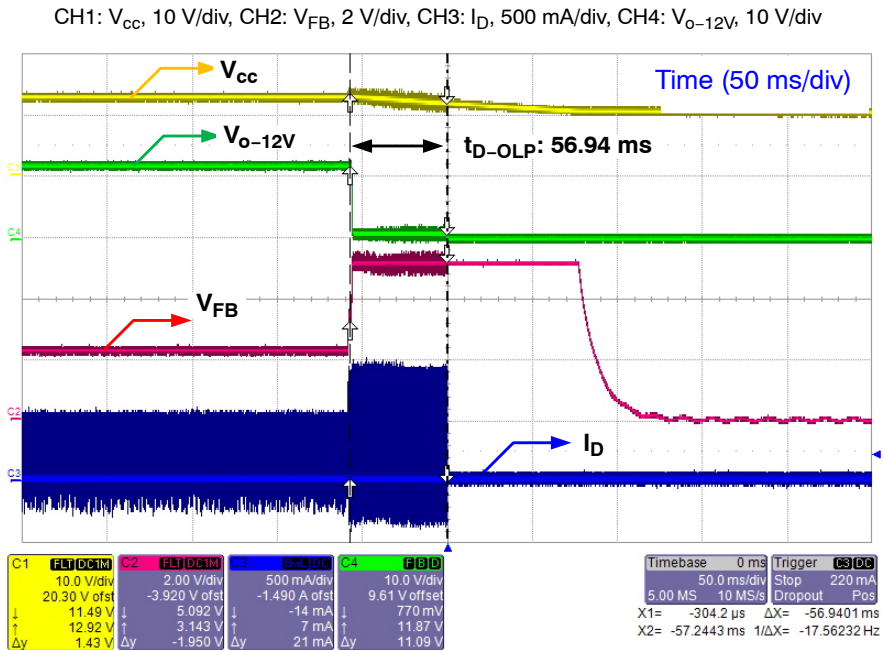

Figure 32. OLP @ 230  $V_{ac}$ /60 Hz

# NCP11184A65P25WGEVB

## e. Current Sense Short Protection (CSSP)

- ◆ Startup after sensing resistor short

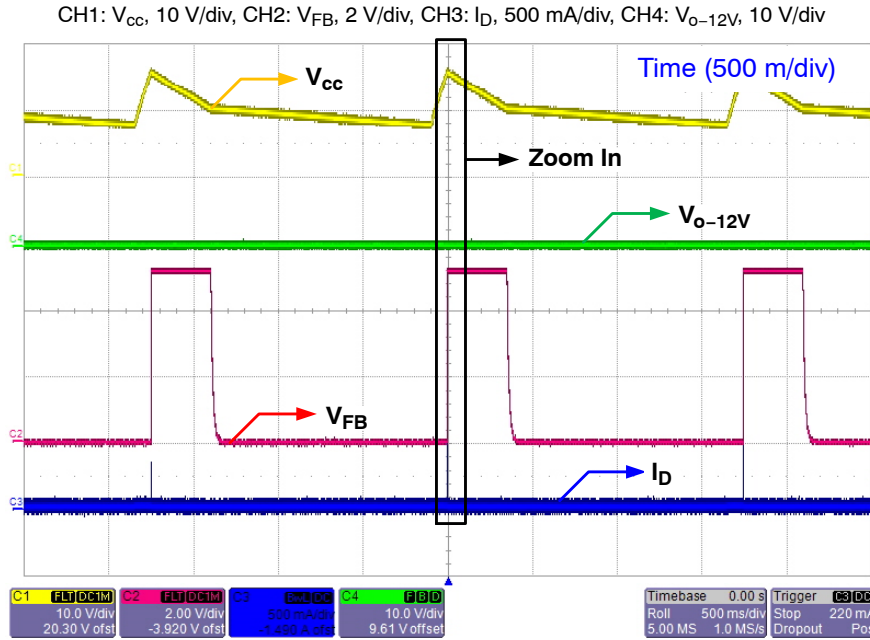

Figure 33. CSSP @ 115  $V_{ac}$ /60 Hz, Full Load (Roll Mode)

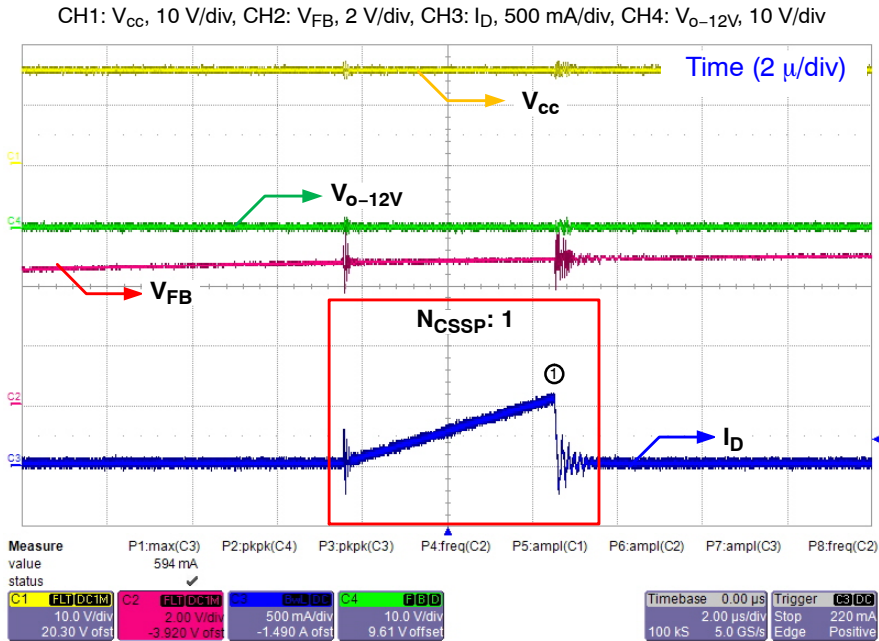

Figure 34. CSSP @ 115  $V_{ac}$ /60 Hz, Full Load (Zoom In)

# NCP11184A65P25WGEVB

CH1:  $V_{CC}$ , 10 V/div, CH2:  $V_{FB}$ , 2 V/div, CH3:  $I_D$ , 500 mA/div, CH4:  $V_{O-12V}$ , 10 V/div

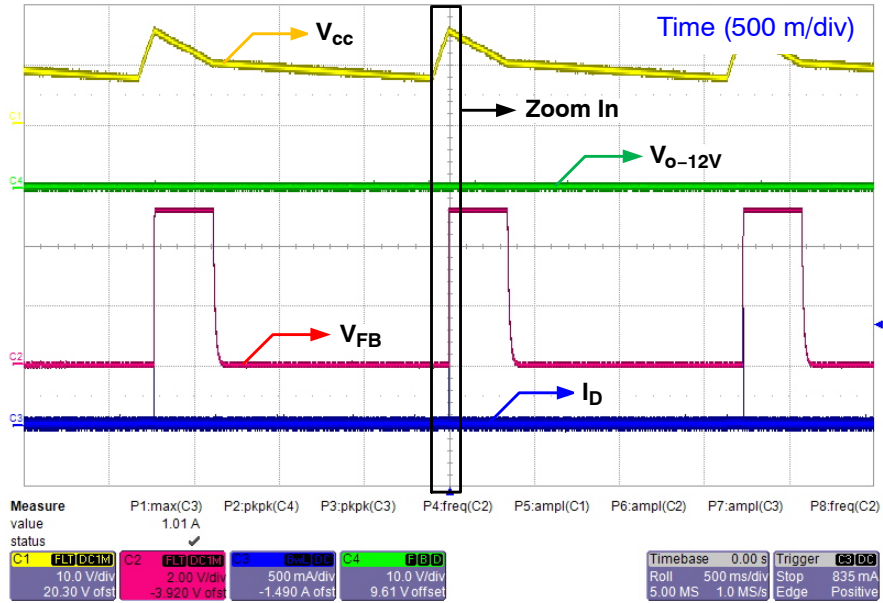

Figure 35. CSSP @ 230  $V_{ac}$ /60 Hz, Full Load (Roll Mode)

CH1:  $V_{CC}$ , 10 V/div, CH2:  $V_{FB}$ , 2 V/div, CH3:  $I_D$ , 500 mA/div, CH4:  $V_{O-12V}$ , 10 V/div

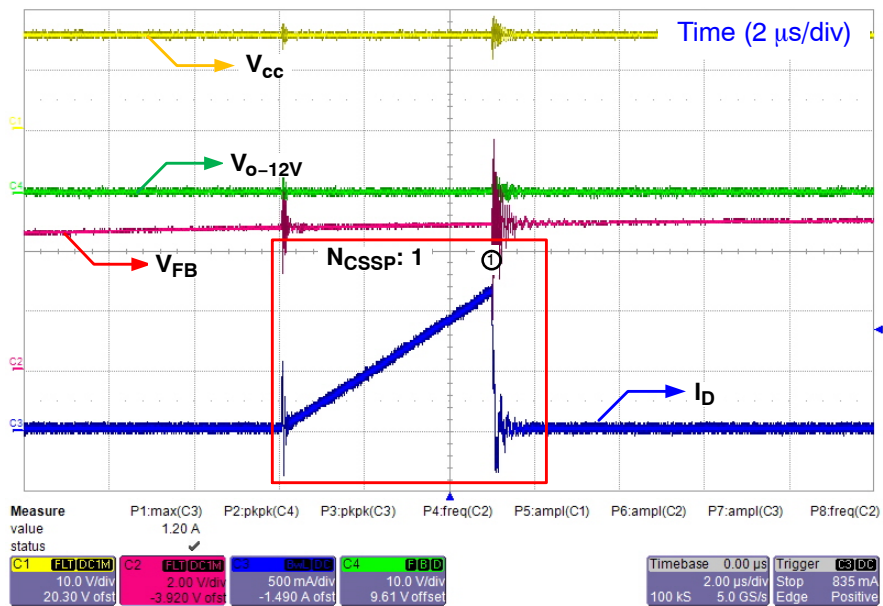

Figure 36. CSSP @ 230  $V_{ac}$ /60 Hz, Full Load (Zoom In)

# NCP11184A65P25WGEVB

- ◆ Short sensing resistor while normal operation

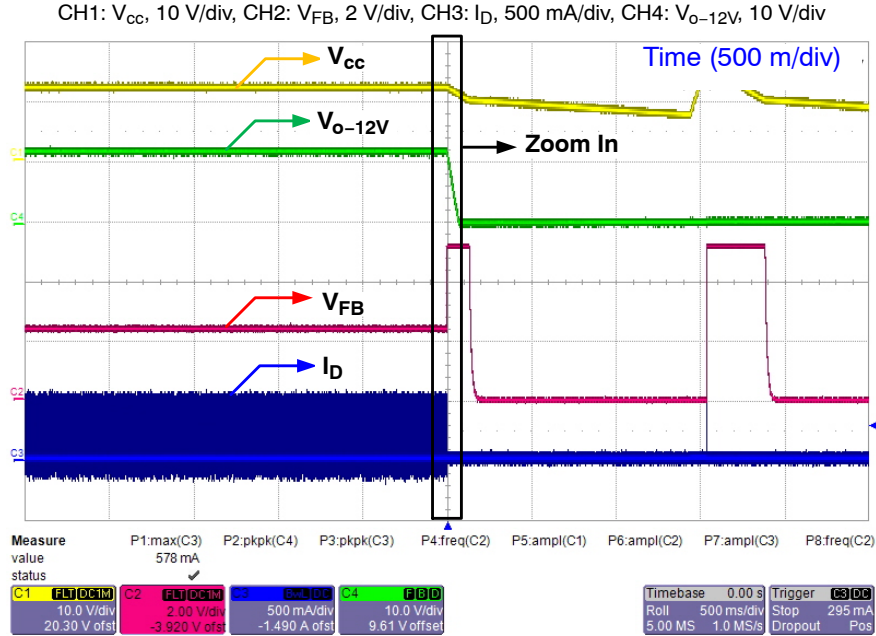

Figure 37. CSSP @ 115  $V_{ac}$ /60 Hz, Full Load (Roll Mode)

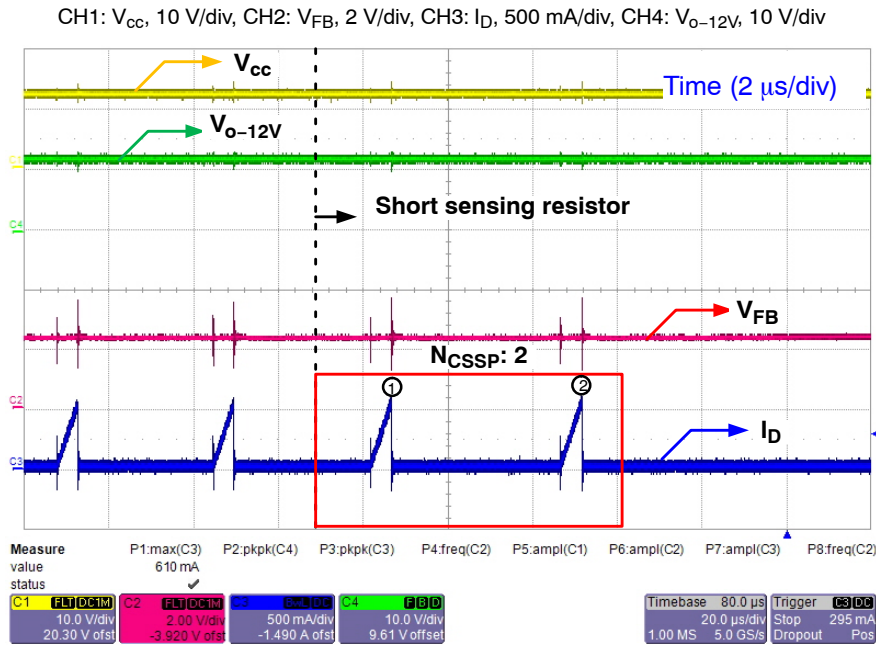

Figure 38. CSSP @ 115  $V_{ac}$ /60 Hz, Full Load (Zoom In)



# NCP11184A65P25WGEVB

CH1:  $V_{cc}$ , 10 V/div, CH2:  $V_{FB}$ , 2 V/div, CH3:  $I_D$ , 500 mA/div, CH4:  $V_{o-12V}$ , 10 V/div

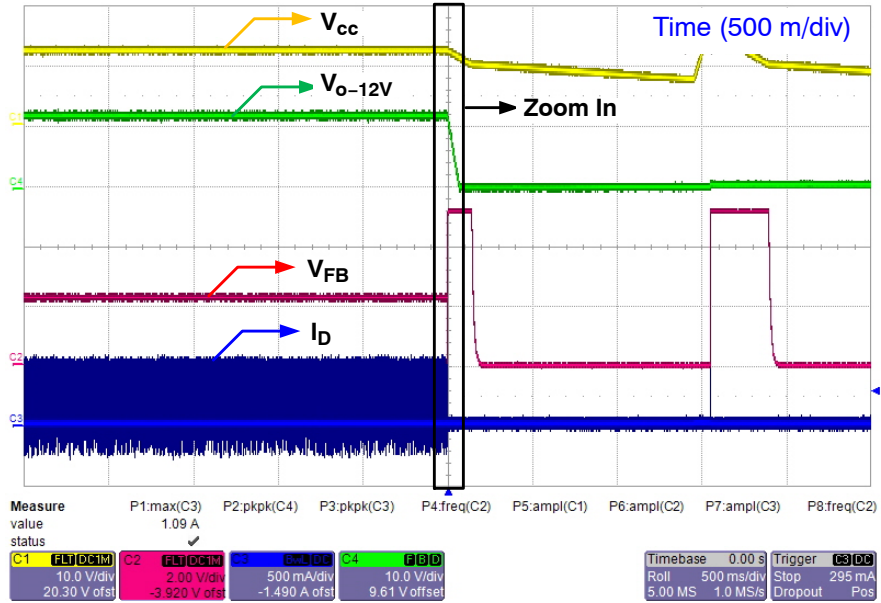

Figure 39. CSSP @ 230  $V_{ac}$ /60 Hz, Full Load (Roll Mode)

CH1:  $V_{cc}$ , 10 V/div, CH2:  $V_{FB}$ , 2 V/div, CH3:  $I_D$ , 500 mA/div, CH4:  $V_{o-12V}$ , 10 V/div

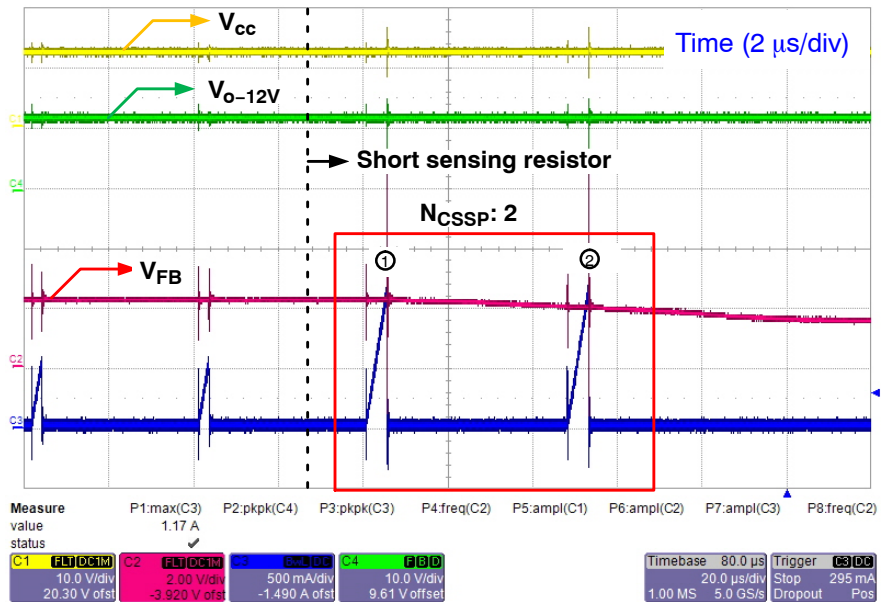

Figure 40. CSSP @ 230  $V_{ac}$ /60 Hz, Full Load (Zoom In)

# NCP11184A65P25WGEVB

## f. Thermal Shutdown Protection (TSD)

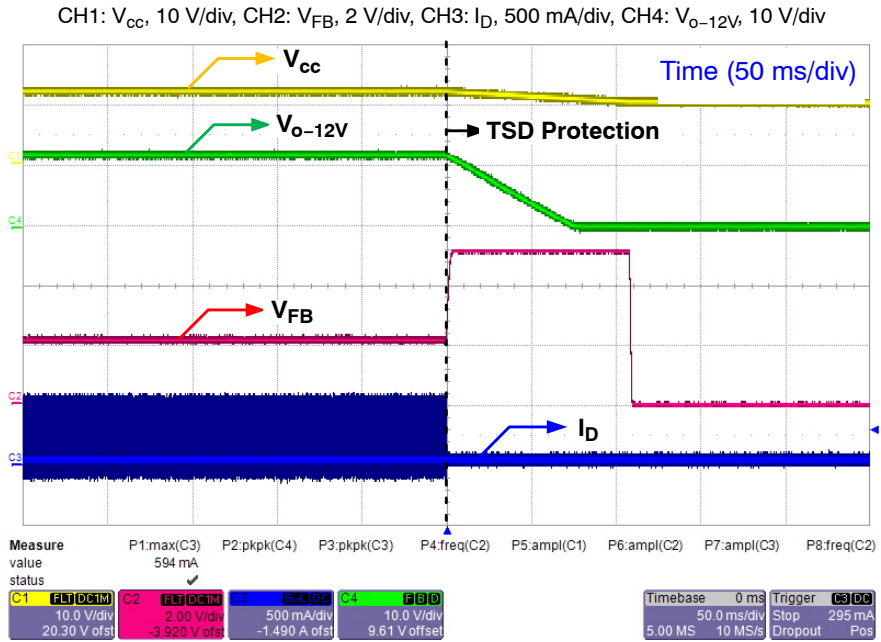

Figure 41. TSD @ 115  $V_{ac}$ /60 Hz, Full Load

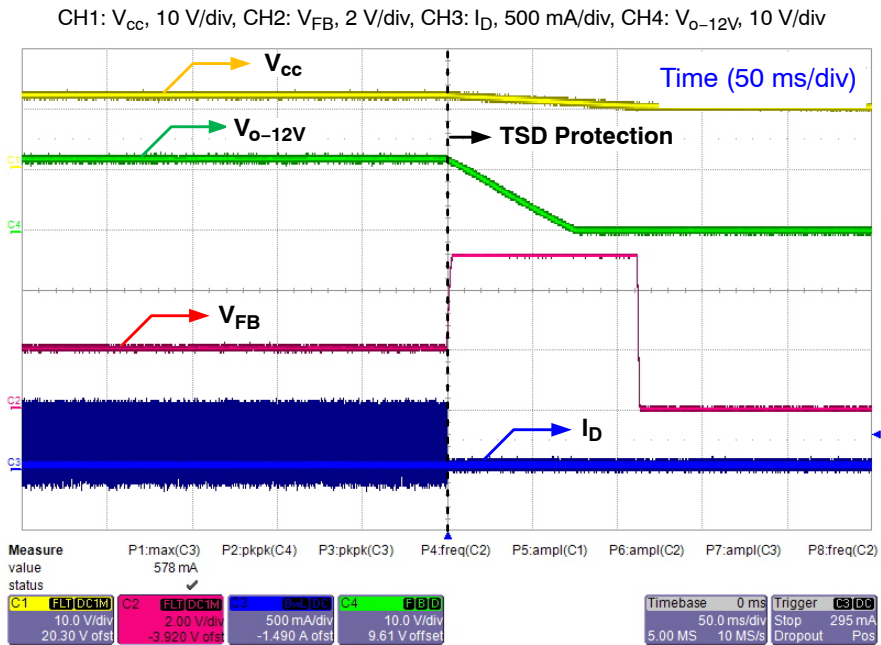

Figure 42. TSD @ 230  $V_{ac}$ /60 Hz, Full Load

# NCP11184A65P25WGEVB

## BILL OF MATERIALS

Part	Qty	Description	Value	Tolerance	Footprint	Manufacturer	Manufacturer Part Number
C101	1	Electrolytic Capacitor	68 $\mu$ F / 450 V		18 x 25 mm	SAMYOUNG	NFA
C102	1	MLCC X7R Capacitor	2 nF / 10 V	$\pm$ 5%	0805	Murata	
C104	1	MLCC X7R Capacitor	100 nF / 50 V	$\pm$ 5%	0805	Murata	
C105	1	Electrolytic Capacitor	47 $\mu$ F / 35 V		5 x 11 mm	SAMYOUNG	NXH
C106	1	MLCC X7R Capacitor	1 nF / 10 V	$\pm$ 5%	0805	Murata	
C201, C204	2	MLCC X7R Capacitor	100 pF / 630 V	$\pm$ 5%	1206	Yageo	CC1206JKNPOZBN101
C202, C203	2	Electrolytic Capacitor	150 $\mu$ F / 25 V		6.3 x 11 mm	SAMYOUNG	NXH
C205, C206	2	Electrolytic Capacitor	680 $\mu$ F / 25 V		10 x 16 mm	SAMYOUNG	NXH
C207	1	MLCC X7R Capacitor	27 nF / 25 V	$\pm$ 5%	0603	Murata	
CX101	1	X2 Capacitor	0.33 $\mu$ F / 275 V	$\pm$ 10%	8.5 x 13.5 x 18 mm	PILKOR	PCX2 337
CY101	1	Y1 Capacitor	4700 pF / 250 V	$\pm$ 20%	CY4.5 x 13	Murata	DE6E3KJ472MB3B
R101, R102, R103	3	Resistor SMD	10 M	$\pm$ 1%	1206	Rohm	
R104	1	Resistor SMD	270 k	$\pm$ 1%	0805	Rohm	
R107	1	Resistor SMD	4.7	$\pm$ 1%	0805	Rohm	
R108	1	Resistor SMD	3.6	$\pm$ 1%	1206	Rohm	
R109, R110, R111	3	Resistor SMD	3.3	$\pm$ 1%	1206	Rohm	
R201, R202, R203, R204	4	Resistor SMD	110	$\pm$ 1%	1206	Rohm	
R205	1	Resistor SMD	750	$\pm$ 1%	0603	Rohm	
R206	1	Resistor SMD	1.2 k	$\pm$ 1%	0603	Rohm	
R207	1	Resistor SMD	2 M	$\pm$ 1%	0603	Rohm	
R208	1	Resistor SMD	160 k	$\pm$ 1%	0603	Rohm	
R209	1	Resistor SMD	9.1 K	$\pm$ 1%	0603	Rohm	
R210	1	Resistor SMD	56 k	$\pm$ 1%	0603	Rohm	
R211, R212	2	Resistor SMD	20 k	$\pm$ 1%	0603	Rohm	
D101, D102	2	Super Fast Rectifier	1000 V, 1 A		SMB	ON Semiconductor	MURS160T3G
D201, D202	2	Schottky Rectifier	150 V, 10 A		TO-277	ON Semiconductor	FSV10150V
ZD101	1	TVS	220 V, 600 W		DO-15	ON Semiconductor	P6KE220A
BD101	1	Bridge Rectifier	600 V, 1.5 A		SDIP 4L	ON Semiconductor	DF06S
LF101	1	Common-mode Choke	40 mH / 1.3 A		21*10 mm	TNC	CV613400SH
L201	1	Radial Lead Inductor	1.5 $\mu$ H / 5.4 A	$\pm$ 20%	8.7 x 10 mm, 5.0 mm pitch	BOURNS	RLB0912-1R5ML
L202	1	Radial Lead Inductor	1.5 $\mu$ H / 0.92 A	$\pm$ 20%	5 x 6.5, 2.0 mm pitch	BOURNS	RLB0608-1R5ML

# NCP11184A65P25WGEVB

## BILL OF MATERIALS (continued)

Part	Qty	Description	Value	Tolerance	Footprint	Manufacturer	Manufacturer Part Number
T201	1	Transformer	1.4 mH	±10%	EE25, 10 Pin bobbin	TDK	EE-25
F101	1	Radial Lead Fuse	250 Vac, 1 A		SS-5	Little Fuse	392 1000 0000
U101	1	PWM with integrated Power switcher	NCP11184		7DIP	ON Semiconductor	NCP11184
U201	1	Opto coupler	CTR = 80-160%		DIP 4-pin	ON Semiconductor	FOD817A
U202	1	Shunt Regulator	Adjustable, 2.5 V	1%	SOT-23F 3L	ON Semiconductor	NCP431BCSNT1G
CN101	1	Connector	3Pin		pitch 3.96 mm	MOLEX	5273-03A
CN201	1	Connector	4Pin		pitch 3.96 mm	MOLEX	5273-04A
JP1	1	Jumper wire	short		13.5 mm		
PCB	1	PCB					

**onsemi**, **Onsemi**, and other names, marks, and brands are registered and/or common law trademarks of Semiconductor Components Industries, LLC dba "**onsemi**" or its affiliates and/or subsidiaries in the United States and/or other countries. **onsemi** owns the rights to a number of patents, trademarks, copyrights, trade secrets, and other intellectual property. A listing of **onsemi**'s product/patent coverage may be accessed at [www.onsemi.com/site/pdf/Patent-Marking.pdf](http://www.onsemi.com/site/pdf/Patent-Marking.pdf). **onsemi** is an Equal Opportunity/Affirmative Action Employer. This literature is subject to all applicable copyright laws and is not for resale in any manner.

The evaluation board/kit (research and development board/kit) (hereinafter the "board") is not a finished product and is not available for sale to consumers. The board is only intended for research, development, demonstration and evaluation purposes and will only be used in laboratory/development areas by persons with an engineering/technical training and familiar with the risks associated with handling electrical/mechanical components, systems and subsystems. This person assumes full responsibility/liability for proper and safe handling. Any other use, resale or redistribution for any other purpose is strictly prohibited.

**THE BOARD IS PROVIDED BY ONSEMI TO YOU "AS IS" AND WITHOUT ANY REPRESENTATIONS OR WARRANTIES WHATSOEVER. WITHOUT LIMITING THE FOREGOING, ONSEMI (AND ITS LICENSORS/SUPPLIERS) HEREBY DISCLAIMS ANY AND ALL REPRESENTATIONS AND WARRANTIES IN RELATION TO THE BOARD, ANY MODIFICATIONS, OR THIS AGREEMENT, WHETHER EXPRESS, IMPLIED, STATUTORY OR OTHERWISE, INCLUDING WITHOUT LIMITATION ANY AND ALL REPRESENTATIONS AND WARRANTIES OF MERCHANTABILITY, FITNESS FOR A PARTICULAR PURPOSE, TITLE, NON-INFRINGEMENT, AND THOSE ARISING FROM A COURSE OF DEALING, TRADE USAGE, TRADE CUSTOM OR TRADE PRACTICE.**

**onsemi** reserves the right to make changes without further notice to any board.

You are responsible for determining whether the board will be suitable for your intended use or application or will achieve your intended results. Prior to using or distributing any systems that have been evaluated, designed or tested using the board, you agree to test and validate your design to confirm the functionality for your application. Any technical, applications or design information or advice, quality characterization, reliability data or other services provided by **onsemi** shall not constitute any representation or warranty by **onsemi**, and no additional obligations or liabilities shall arise from **onsemi** having provided such information or services.

**onsemi** products including the boards are not designed, intended, or authorized for use in life support systems, or any FDA Class 3 medical devices or medical devices with a similar or equivalent classification in a foreign jurisdiction, or any devices intended for implantation in the human body. You agree to indemnify, defend and hold harmless **onsemi**, its directors, officers, employees, representatives, agents, subsidiaries, affiliates, distributors, and assigns, against any and all liabilities, losses, costs, damages, judgments, and expenses, arising out of any claim, demand, investigation, lawsuit, regulatory action or cause of action arising out of or associated with any unauthorized use, even if such claim alleges that **onsemi** was negligent regarding the design or manufacture of any products and/or the board.

This evaluation board/kit does not fall within the scope of the European Union directives regarding electromagnetic compatibility, restricted substances (RoHS), recycling (WEEE), FCC, CE or UL, and may not meet the technical requirements of these or other related directives.

FCC WARNING – This evaluation board/kit is intended for use for engineering development, demonstration, or evaluation purposes only and is not considered by **onsemi** to be a finished end product fit for general consumer use. It may generate, use, or radiate radio frequency energy and has not been tested for compliance with the limits of computing devices pursuant to part 15 of FCC rules, which are designed to provide reasonable protection against radio frequency interference. Operation of this equipment may cause interference with radio communications, in which case the user shall be responsible, at its expense, to take whatever measures may be required to correct this interference.

**onsemi** does not convey any license under its patent rights nor the rights of others.

LIMITATIONS OF LIABILITY: **onsemi** shall not be liable for any special, consequential, incidental, indirect or punitive damages, including, but not limited to the costs of requalification, delay, loss of profits or goodwill, arising out of or in connection with the board, even if **onsemi** is advised of the possibility of such damages. In no event shall **onsemi**'s aggregate liability from any obligation arising out of or in connection with the board, under any theory of liability, exceed the purchase price paid for the board, if any.

The board is provided to you subject to the license and other terms per **onsemi**'s standard terms and conditions of sale. For more information and documentation, please visit [www.onsemi.com](http://www.onsemi.com).

## PUBLICATION ORDERING INFORMATION

### LITERATURE FULFILLMENT:

Email Requests to: [orderlit@onsemi.com](mailto:orderlit@onsemi.com)

**onsemi Website:** [www.onsemi.com](http://www.onsemi.com)

### TECHNICAL SUPPORT

**North American Technical Support:**

Voice Mail: 1 800-282-9855 Toll Free USA/Canada

Phone: 011 421 33 790 2910

**Europe, Middle East and Africa Technical Support:**

Phone: 00421 33 790 2910

For additional information, please contact your local Sales Representative